

MAE MANUFACTURERS cc

MANUFACTURERS OF THE MAE FLAMEPROOF ALTERNATOR AND ELECTRICAL FLAMEPROOF EQUIPMENT

REG NO: CK 95/47371/23 VAT NO: 447 011 0034

Tel: +27 (11) 421 5551

Fax: +27 (11) 421 5618

E-mail: orders@maesa.co.za / admin@maesa.co.za

MAE Flameproof Directional Headlight

Part No: MAEFLL



Product Features

- ❖ 110, 220, 12 or 24 Volts.
- ❖ Cushion Mount Lamp.
- ❖ No Rust (Brass Enclosure).
- ❖ Available in Red or Green, Flashing or Non-Flashing
- ❖ Available in Green/Blue Combination or Green/Red Combination, Non-Flashing.
- ❖ Directional Box optional.
- ❖ No Enclosure Replacement As All Components Are Interchangeable.



Members: M. Lo Giudice; G. Lo Giudice;

MAE MANUFACTURERS cc

MANUFACTURERS OF THE MAE FLAMEPROOF ALTERNATOR AND ELECTRICAL FLAMEPROOF EQUIPMENT

REG NO: CK 95/47371/23 VAT NO: 447 011 0034

Tel: +27 (11) 421 5551

Fax: +27 (11) 421 5618

E-mail: orders@maesa.co.za / admin@maesa.co.za

Technical Specifications

Voltage

110V, 220V, 12V or 24V

Certificate

MASC M/13-644X (RSA)

ANZEx 14.4135X (AUS)

CML 14 ATEX 1022 (EUROPE)

Weight

5kg

Overall Length

136.5mm

Overall Width

127mm

Overall Height

92mm

Overall Diameter

86mm

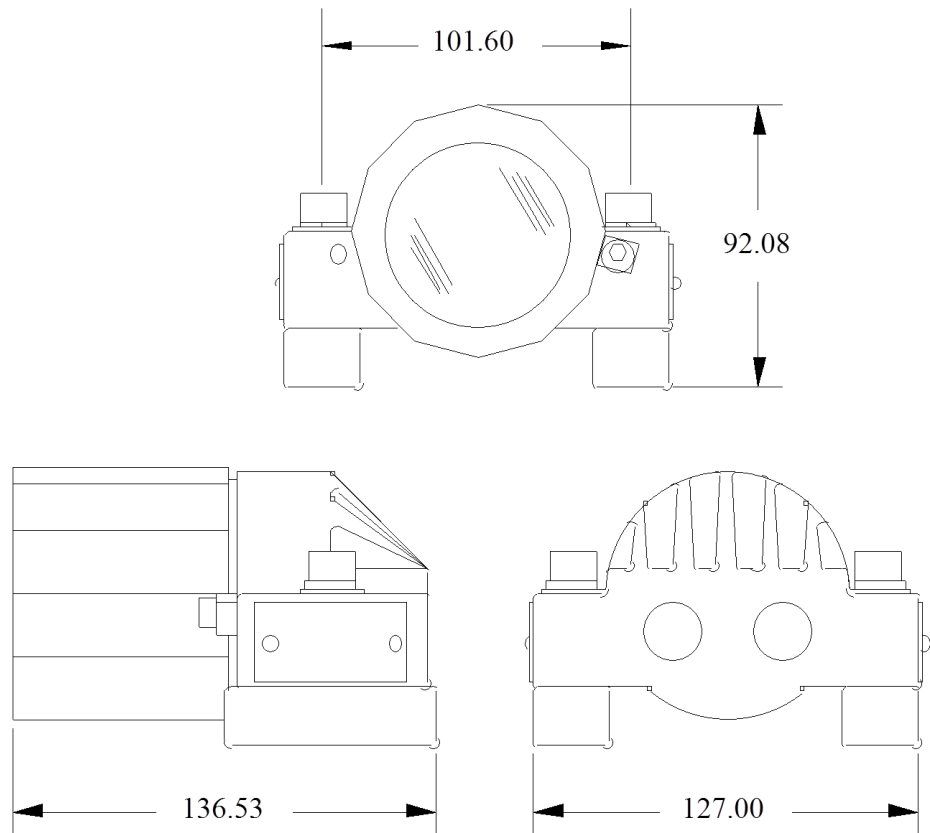

MAE MANUFACTURERS cc

MANUFACTURERS OF THE MAE FLAMEPROOF ALTERNATOR AND ELECTRICAL FLAMEPROOF EQUIPMENT















REG NO: CK 95/47371/23 VAT NO: 447 011 0034

Tel: +27 (11) 421 5551

Fax: +27 (11) 421 5618

E-mail: orders@maesa.co.za / admin@maesa.co.za

Application

 SCOOP		 QUARRY VEHICLES		 LONG WALL SHIELD	
 CONTINUOUS MINER		 SHUTTLE CAR		 HAULAGE	
 DUMP TRUCK		 DRILLS		OTHER APPLICATIONS	

Interchangeable Inners

Interchangeable With Any
MAE Flameproof Head
Lamp Products

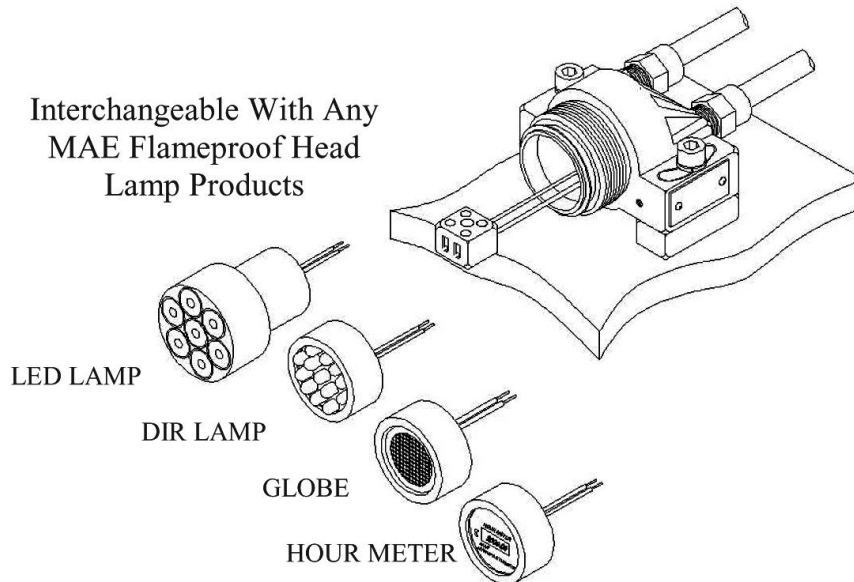

Disclaimer

The information in this specification is derived from the latest model available at the time of issue 1.0. While every precaution has been taken to ensure the accuracy of the content, no responsibility can be accepted for any errors or omissions nor any misinterpretation or misapplication. MAE has adopted a continuous product improvement policy and therefore, specifications are subject to change without prior notice © September 2009 MAE all rights reserved.



FLAMEPROOF HEAD LIGHT

MODEL: 1A

DIR CHART	
GREEN BLUE	MFLGED/GB
GREEN RED	MFLGED/GR
GREEN	MFLGED/G
RED	MFLGED/R
GREEN FLASH	MFLGED/GF
RED FLASH	MFLGED/RF
AVAILABLE IN	12, 24, 110 & 220V

PART NO. :
 HEAD LIGHT - MAEFL001224
 LED HEAD LAMP - MAEFLD
 DIR GREEN - MAEFLG/G
 DIR RED - MAEFLR/R
 DIR GREEN FLASH - MAEFLG/GF
 DIR RED FLASH - MAEFLR/RF

PART NO. :
 DIR GREEN RED - MAEFL/GR
 DIR GREEN BLUE - MAEFL/GB
 HOUR METER - MAEFLH

Ex dI 150°C

BULB TABLE

12v	CLEAR	50w	MAEG12
12v	YELLOW	50w	MAEG12G
12v	GREEN	50w	MAEG12G
12v	RED	50w	MAEG12R
24v	CLEAR	50w	MAEG24
110v	CLEAR	50w	MAEG110
220v	CLEAR	50w	MAEG220

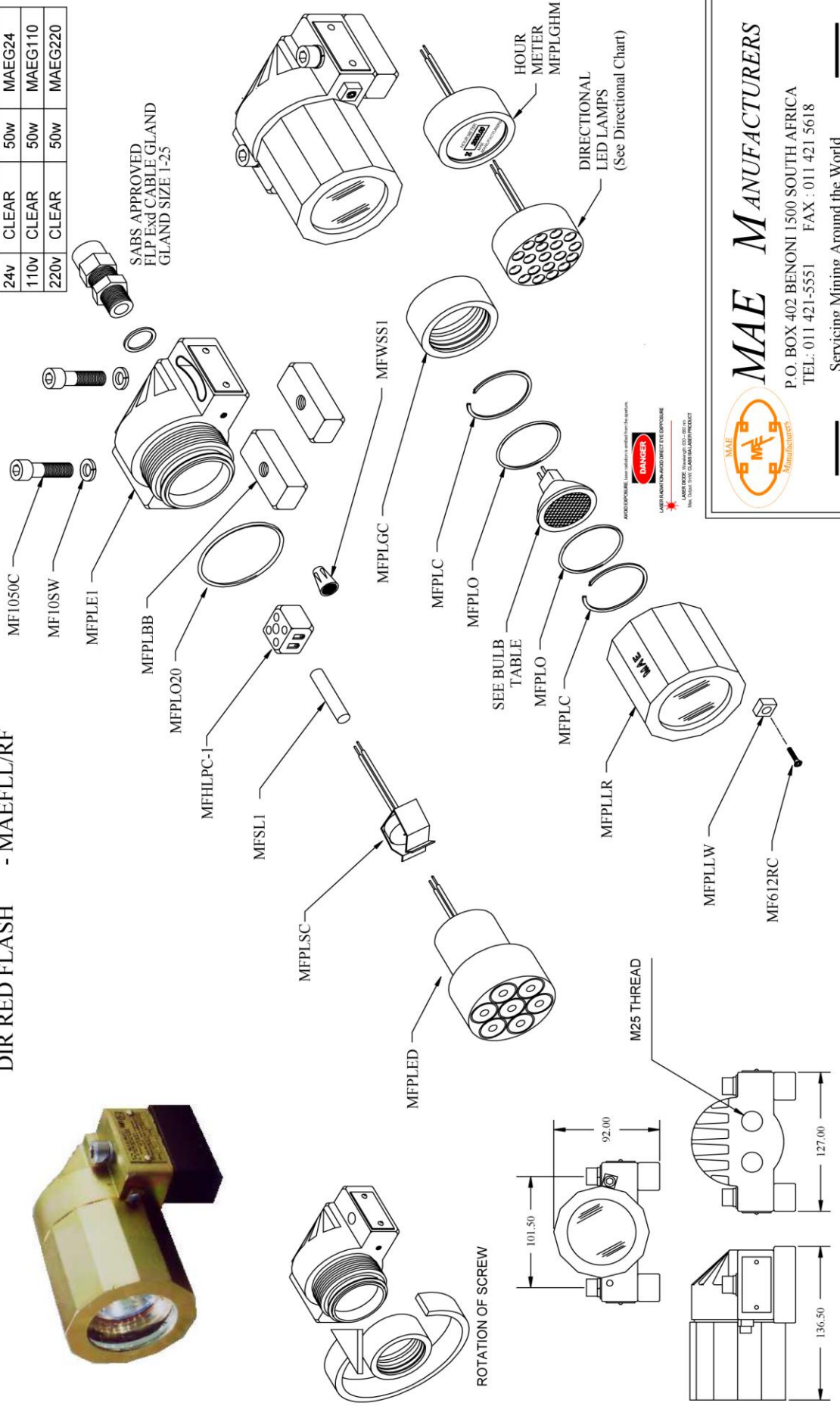

MAE MANUFACTURERS
 P.O. BOX 402 BENONI 1500 SOUTH AFRICA
 TEL: 011 421-5551 FAX : 011 421 5618
 Servicing Mining Around the World